

Bimba Original Line – Stainless Steel Body Air Cylinders

How to Order

The model number of all Original Line cylinders consists of three alphanumeric clusters. These designate product type, bore size and stroke length, and mounting styles and options.

Please refer to the charts below for an example of model number BR-013-DBEE0.5. This is a rear block, 7/16" bore, 3" stroke double acting cylinder with bumpers and an extra extension of 1/2".

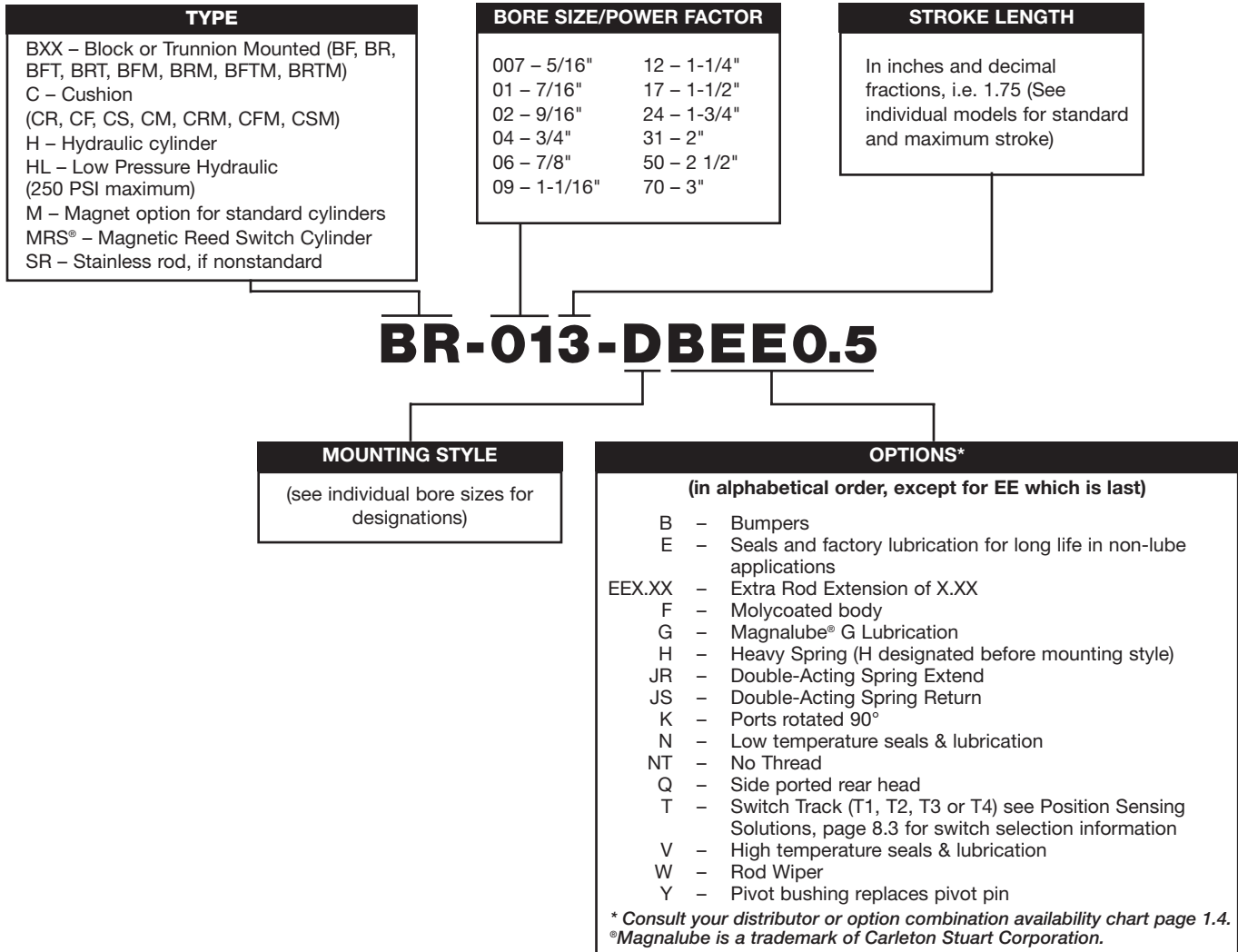

Approximate Power Factors

5/16" – 0.07
7/16" – 0.15
9/16" – 0.25
3/4" – 0.4
7/8" – 0.6
1-1/16" – 0.9
1-1/4" – 1.2
1-1/2" – 1.7
1-3/4" – 2.4
2" – 3.1
2-1/2" – 5.0
3" – 7.0

$$FORCE = \frac{Airline\ Pressure}{14.7} \times Piston\ Area$$

$$PISTON\ AREA = \frac{Bimba\ Power\ Factor}{14.7}$$

$$FORCE = \frac{Airline\ Pressure}{14.7} \times Bimba\ Power\ Factor$$

Bimba has made sizing a cylinder as easy as knowing the model number. Each base model number is developed by calculating the area of the cylinder bore. This area, or Power Factor, will provide the force the cylinder will exert when multiplied by the airline pressure.

Bimba Original Line – Stainless Steel Body Air Cylinders

Options

Many options can be added to our standard cylinders. Options vary by bore size. See individual bore sizes for valid options, pricing and length adders for that size. Consult specific cylinder types in this catalog for options available for those cylinder types.

Option Combination Availability Chart

Due to design or compatibility restrictions, the following options may **NOT** be ordered in combination. For example, option K (ports rotated) and option Q (side ported rear head) are not a valid combination.

Options F, NT and EE are available independently, with each other or with all other options or viable option combinations.

options size	W3 4 Wiper	B2 Bumper	V2 4 High Temperature	H Heavy Spring	K Ports Rotated 90°	Y Pivot Bushing	N2 Low Temperature	Q Side Ported Rear Head	G Magnalube G	E Special Lube & Seals	HL 5 Low Pressure Hydraulic
007	N/A	STD	N, E	N/A	Q	STD	V,G,E, HL	K	N, E, HL	N, G, V, HL	G,N,E,F,H
01	N/A	N, HL	N, E	N/A	Q	Q	B,V,G,E, HL	K,Y	N, E, HL	N, G, V, HL	B,G,N,E,F,H
02	N/A	N, HL	N, E	N/A	Q	STD	B,V,G,E, HL	K	N, E, HL	N, G, V, HL	B,G,N,E,F,H
04, 09, 17	H,N	N, HL	N, E	W, HL	Q	Q	W,B,V,G,E, HL	K,Y	N, E, HL	N, G, V, HL	B,G,N,E,F,H
06, 12, 24	N/A	STD, HL	N, E	N/A	Q	Q	V,G,E, HL	K,Y	N, E, HL	N, G, V, HL	B,G,N,E,F,H
31, 50	N/A	N, HL	N, E	N/A	Q	STD	B,V,G,E, HL	K	N, E, HL	N, G, V, HL	B,G,N,E,F,H
70	N/A	N, HL	N, E	N/A	Q	STD	V,G,E, HL	K	N, E, HL	N, G, V, HL	B,G,N,E,F,H

Notes:

- Option M is designated as a prefix, (ie M-041-DXP). When M is specified, the piston rod will be made of 303 stainless steel. Certain bore sizes and mounting styles offer the stainless rod standard.
- When bumpers are standard and high or low temperature option is specified, the bumpers are omitted and the overall length of the cylinder may decrease. When bumpers and high temperature are ordered as options on the same cylinder, the bumper material will be standard Buna N.
- Wipers are available in double acting and reverse single acting models only. Wipers may not be available with certain mounting configurations. Consult the specific bore size in this catalog for detail.
- When high temperature and the magnetic options are combined, operating temperature remains at 200°F. This combination is recommended when Fluoroelastomer seals are specified for compatibility. When specifying the high temperature and wiper options together, a standard Buna N or Urethane wiper will be provided.
- Option HL applies only to Double Acting Original Line cylinders and is not available with the following series: Cushion, PC, MRS, NR, Z-Line, DNR, 500 Hydraulic and Multiple Position.

Overall Length Reductions for Options N & V

Double Acting	
0070-DV	N/A
0070-DXPN	.08"
BF-0070-DN	.08"
060-D (V or N)	.22"
060-DXP (V or N)	.22"
060-DXDE (V or N)	.25"
120-D (V or N)	.19"
120-DP (V or N)	.19"
120-DXDE (V or N)	.25"
120-DXDEH (V or N)	.25"
240-D (V or N)	.25"
240-DP (V or N)	.25"
240-DXDE (V or N)	.25"

Single Acting	
0070-N	.04"
0070-XPN	.04"
0070-RN	.04"
0070-RPN	.04"
060- (V or N)	.09"
060-NR (V or N)	.09"
060-RP (V or N)	.125"
060-R (V or N)	.125"
120- (V or N)	.125"
120-NR (V or N)	.125"
120-NRP (V or N)	.125"
120-P (V or N)	.125"
120-R (V or N)	.125"
120-RP (V or N)	.125"
240- (V or N)	.125"
240-NR (V or N)	.125"
240-P (V or N)	.125"
240-R (V or N)	.125"

The switch track and port orientation when ordering the "Z" (Switch Track) & "K" (Ports Rotated) options on an Original Line MRS cylinder is shown Below. Double track option Z and K cannot be ordered in combination.

MRS- -DXP



MRS- -DXPZK

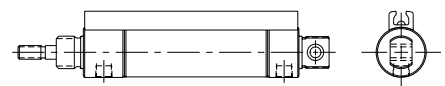

*0070 bumpers are high temperature option material and not removed when high temperature option is specified.

Bimba Original Line – Stainless Steel Body Air Cylinders

Accessories

Accessories have separate catalog numbers and are shown at the end of each bore size section. Most accessories are zinc-plated carbon steel. We also offer stainless steel accessories in some bore sizes.

Lubrication

All BIMBA cylinders are prelubricated with our special HT-99 lubrication and sealed at the factory for extensive maintenance-free life. Cylinder life can be lengthened by providing additional lubricant with an air line mist lubricator or direct introduction of oil to the cylinder every 500 hours of operation. Both Magnalube G and HT-99 can now be purchased from your Bimba distributor.

MAG-G-3CC \$7.35/bag
HT-99-7CC \$4.05/bag
(each bag contains six ampules)

Requirements will vary depending on the application. In general, one ampule will provide 500 hours of lubrication service for one 1-1/2" bore, 12" stroke double acting cylinder.

Other recommended oils for Buna N seals are medium to heavy inhibited, nondetergent hydraulic and general purpose oil. For cylinders with high temperature seals, use Dow Corning #710. For cylinders with low temperature seals, Dow Corning #55 grease is recommended.

Magnalube G can be ordered by specifying option G. Magnalube G's non-migratory properties provide benefits in applications where migration of lubricant can be problematic for cylinder performance or the application. Molycoating is available as standard option F. It is a dry, thin film of lubricant on the cylinder wall that can reduce piston seal wear. Bimba's new option E provides a proprietary combination of seal material and lubrication for extended life in non-lubricated environments. Other types of factory lubrication are available as required.

Piston Rod Material

Standard models feature ground and polished, high strength carbon steel piston rod or ground and roller burnished type 303 stainless steel. Stainless steel can also be ordered as an option on most models (see models for pricing). Stainless steel is standard on the following models:

- All 5/16", 7/16" and 9/16" bore cylinders
- All cylinders with adjustable cushions
- All 9/16" through 3" bore cylinders ordered with Magnet (M) option
- MRS cylinders
- "Z" Line cylinders
- Block and Trunnion-mounted cylinders
- Universal mount, double-end rod cylinders

Hard chrome plated rod is standard on "500" Hydraulic cylinders.

Temperature Range

Buna N seals with a temperature range of -20° F (-29° C) to 200° F (95° C) are standard in all BIMBA air cylinders. Fluoroelastomer seals rated for higher temperature applications (up to 400° F) are available. When specifying our magnetic piston ("M" option), maximum operating temperature is 185° F based on the material of the magnet. If cylinders are operated at temperatures below 0° F for extended time periods, our low temperature seal and lubrication option (N) is recommended. This option has a temperature range of -40° F to 200° F. If cylinders are operated below -20° F with low temperature seals for extended time periods, cylinder performance will be affected by the cold temperature.

Bimba Original Line – Stainless Steel Body Air Cylinders

Mounting

Mounting should be by the threaded stud ends, pivot or bolt holes provided. Mount cylinders to provide alignment with the driven mechanism, avoiding side loads that restrict the free operation of the cylinder.

Free Test Cylinder

Since 1975, our policy has been to provide a FREE TEST CYLINDER to any qualified original equipment manufacturer. This service is provided at no obligation, but we would appreciate a copy of your test results. Contact us or your local stocking BIMBA distributor for more information.

Special Cylinders

Do you have a complicated or unusual application? BIMBA will custom-design and build the cylinder that will solve your problem. Whatever your needs—special stroke, mounting styles, rod-end configurations, seal materials, dimensional changes, etc.—contact us or your local stocking BIMBA distributor.

Delivery/ Availability

Bimba cylinders are sold through local stocking distributors. Each distributor maintains an inventory of our most popular models. At the factory, Bimba classifies cylinders as shelving and nonshelving models. More than 125,000 units of various shelving models are kept in stock for immediate delivery. Standard stroke lengths shown in blue are stocked at Bimba. (Most stocked models shown in blue do not include options.) These stroke lengths are available in limited quantities for immediate shipment. Bimba also stocks a large quantity of cylinders with options such as stainless steel rods or bumpers. Nonstocked standard models are manufactured within 5 working days.

Cylinder Life Expectancy

Bimba cylinders have been designed and tested for a rated life of 1,400 miles of travel when properly applied and lubricated per recommendations. Bimba's option E has been designed and tested for a rated life of 2,800 miles of travel when properly applied in an unlubricated environment.

Bimba Original Line – Stainless Steel Body Air Cylinders

Types of Cylinders

Bimba manufactures several different types of Original Line cylinders for your applications. These include the basic 5/16" to 3" bore cylinders described on pages 1.10-1.64. Weights published for each cylinder are approximate. Additional styles include:

Three-Position Cylinders

This multi-position Original Line stainless body cylinder provides three positive stroke positions with a single cylinder.

Cushion Cylinders

These include adjustable air cushions that slow cylinder speed at the end of stroke, reducing impact and extending cylinder life. Cushions can be ordered on rear, front or both ends, and can be ordered in combination with magnetic pistons.

MRS Cylinders

These include a magnet on the piston, designed to operate Bimba switches to actuate programmable controllers, relays, solenoids, timers or other electrically operated equipment. Dimensional differences from the basic Original Line include larger mounting threads and longer overall lengths in certain bore sizes.

Non-Rotating Cylinders

Double acting and reverse acting non-rotating cylinders have a unique square piston rod with rounded corners. They are dimensionally interchangeable with the standard Original Line.

PC Cylinders

These cylinders include acetal resin end caps. They are ideal for applications and environments that require exposure to moisture, lubricants and specific solvents. All dimensions except 1½" bore nose threads are interchangeable with the Original Line.

All Stainless Steel Non-Repairable Cylinders

The new all stainless Original Line cylinders are the perfect solution for applications in the food processing/packaging, medical, chemical, or marine environments where wash down solutions or other corrosives are present in the environment. Designed to be dimensionally interchangeable with our standard Original Line, these cylinders offer a cost effective method of extending cylinder life in difficult application environments.

All Stainless Steel Repairable Cylinders

The new all stainless repairable Original Line cylinders are ideal for food processing, chemical, medical, pharmaceutical, offshore or marine equipment, and energy production or waste management applications. The bell ring design also offers the added benefit of full reparability without the need for hand tools by securing the body to the rod guide with a knurled, threaded nut.

Z-line Cylinders

For extremely tough applications, with larger diameter, two-piece piston rod, elastomer bumpers and Buna N U-cup seals for low breakaway.

Rod Lock Cylinders

This cylinder is a normally clamped unit that holds the piston rod in position when air pressure is not present. It is ideal for preventing drift at machine shut down.

500 Hydraulic Cylinders

For hydraulic use, up to 500 psi.

Low Pressure Hydraulic Cylinders

Designed for use in low pressure hydraulic circuits with pressures not exceeding 250 psi. The design incorporates chrome plated piston rods and block-vee seals.

Hole Punchers

These are designed to punch millions of holes in thin film or plastic materials 2 to 3 mills thick.

Bimba Original Line – Stainless Steel Body Air Cylinders

Stroke Lengths

Standard stroke lengths and recommended maximum stroke lengths are listed in each model description. Special stroke lengths are available upon request. Stroke lengths are available in lengths longer than published, but an application review may be required. The cost per inch of stroke is listed below the base price of each cylinder. On models with 1/2" standard stroke length increments, add 1/2 of the per inch price for the 1/2" inch of stroke.

NOTE ON ROD MATERIAL: Bore sizes 3/4" to 1-3/4": rod lengths greater than 12" (stroke plus extra extension) require a stainless steel rod. Bore sizes 2" to 3": rod lengths greater than 6" require a stainless steel rod. Rod length equals stroke plus extension.

Fractional Stroke Lengths

Fractional stroke lengths for single and reverse acting cylinders, both standard and nonstandard, require special calculations to determine cylinder dimensions. The following equations apply:

Single Acting Cylinders

Calculate the length of next whole standard increment of stroke, then subtract the difference between desired stroke and next longer whole increment of stroke.

Example: 092.75

$$\begin{array}{r}
 \text{090 Base length} = 1.94" \\
 \text{Plus 1.56 per inch of stroke} = + 4.68" \\
 \text{1.56 X 3.0 (next longer stroke increment)} \\
 \text{093 length} = 6.62 \\
 \text{Whole stroke increment} = 3.00" \\
 \text{Minus desired stroke} = - 2.75 \\
 \text{Stroke difference} = .25 \dots - 0.25 \\
 \text{092.75 length} = 6.37"
 \end{array}$$

Reverse Acting Cylinders

Calculate length of next longer standard increment of stroke, then subtract twice the difference between desired stroke and next longer standard increment of stroke.

Example: 011.625-RP

$$\begin{array}{r}
 \text{010-RP Base length} = 2.38" \\
 \text{Plus 1.44 per each 0.5" of stroke} = + 5.76" \\
 \text{1.44 X 4 (number of standard increments required for the next longer increment)} \\
 \text{012-RP length} = 8.14 \\
 \text{Standard stroke increment} = 2.000" \\
 \text{Minus desired stroke} = - 1.625 \\
 \text{Stroke difference} = .375 \\
 \text{Twice stroke difference} = .750 \dots - 0.75 \\
 \text{011.625 length} = 7.39"
 \end{array}$$

Double Acting Cylinders

Add desired stroke length to base length of cylinder.

Example: 041.25-D

$$\begin{array}{r}
 \text{040-D Base Length} = 2.97" \\
 \text{Plus 1.25" stroke} = + 1.25 \\
 \text{041.25-D length} = 4.22
 \end{array}$$

NOTE: Additional charges may be added for small quantity orders of fractional, nonstandard stroke lengths. Consult your local stocking BIMBA distributor.

Spring Forces (approximate)

Bore Size	Heavy Spring			
	Relaxed (lbs.)	Compressed (lbs.)	Relaxed (lbs.)	Compressed (lbs.)
5/16"	.5	1	–	–
7/16"	1	2	–	–
9/16"	2	4	–	–
3/4"	3	6	4	10
7/8"	3	6	–	–
1-1/16"	3	6	6	12
1-1/4"	7.5	15	–	–
1-1/2"	7	14	8.5	17
1-3/4"	11	24	–	–
2"	15	30	–	–

NOTES

- Heavy spring option may increase cylinder overall length
- Spring forces listed are for whole strokes

Bimba Original Line – Stainless Steel Body Air Cylinders

Nose Mount Torque Values

Thread Size	Torque (IN*LB) FT*LB	Bore Size
1/4-28 UNF	(27.6) 2.3	5/16" (007)
3/8-24 UNF	(60) 5	5/16" (007) & 7/16" (01)
7/16-20 UNF	(84) 7	7/16" (01) & 9/16" (02)
1/2-20 UNF	(144) 12	3/4" (04)
5/8-18 UNF	(336) 28	3/4" (04), 7/8" (06) & 1-1/16" (09)
3/4-16 UNF	(480) 40	3/4" (04), 1-1/16" (09), 1-1/4" (12) & 1-1/2" (17)
7/8-16 UNF	(780) 65	1-1/16" (09), 1-1/4" (12) & 1-1/2" (17)
1-14 UNS	(1200) 100	1-1/2" (17) & 1-3/4" (24)
1 1/8-12 UNF	(1320) 110	1-1/2" (17) & 1-3/4" (24)
1 1/4-12 UNF	(1440) 120	2" (31)
1 3/8-12 UNF	(1560) 130	2-1/2" (50)
1 1/2-12 UNF	(1680) 140	3" (70)

Pressure Rating

Original Line, Cushioned Original Line, NR series, Z-line, MRS and hole punchers = 250 psi.
 PC cylinder = 100 psi.
 Bimba 500 Hydraulic = 500 psi hydraulic.
 Reservoirs = 250 psi.

Switch Track Options

For Original Line cylinders, including MRS cylinders, with -T2, T3, and T4 options

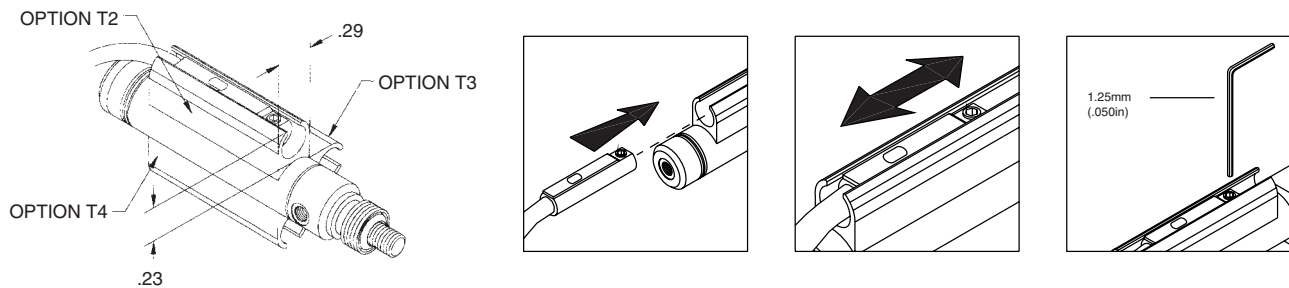

Switch Track for use with Bimba MR, MS, MSC, and MSK Switches

Miniature Position Sensing track lengths can now be purchased separately for field mounting of custom track locations. Simply specify the length of track desired after the part number.

Mounting recommendations:

- Clean body with acetone. Remove all oil from body surface.
- Avoid mounting track over rolled construction. Locate edge of track 0.175" from rolled construction.
- Use a solid continuous bead of glue for the entire length of track used. Bead should fill center channel of track.
- Adhere to recommended cure times as specified by the glue manufacturer.

Bores	Part Number	List Price	Adder per Inch
007 - 04	D-74168-A-length	\$3.20	\$1.15
06 - 31	D-78527-A-length	3.20	1.25
50 - 70	D-78528-A-length	3.20	1.55

Loctite U-05FL or similar adhesive is recommended (not included).

1 - 1/4" Bore Air Cylinders

- Ground and Polished, High Strength Carbon Steel Piston Rod Standard – 303 Stainless Steel Rod Available as an Option – Bronze Rod Guide Bushing Standard
- Force Exerted Approximately 1.2 of Air Line Pressure
- Enclosed Spring Force: 7.5 lbs. Relaxed – 15 lbs. Compressed
- Cushion Quiet Bumpers Standard

OPTIONS:

NO CHARGE:

- **MAGNALUBE G (G)**
- **PORTS ROTATED (K)**
- **NO THREAD (NT)**
- **SIDE PORTED REAR HEAD (Q)**
Add .31" to nose mount overall length
- **PIVOT BUSHING (Y)**
.250" ID

EXTRA EXTENSION (EE)

- Single, reverse and double acting, add \$1.20 per inch of extension
- DXDE, add \$1.80 per inch of extension; extension added to each end
- DXDE hollow rod, add \$1.90 per inch of extension; extension added to each end

DOUBLE ACTING FAILSAFE

(JS = Spring Return, JR = Spring Extend)

- Add \$8.70 to base price + \$1.15 to stroke adder
- See page 1.65 and 1.66 for overall length adders

Enter Stroke Length as 3rd Digit

OPTIONS continued...

MAGNET (prefix M) – Add \$12.90

- Single and reverse acting add .125" to overall length,
- Stainless steel rod becomes standard with this option
- Must specify track(s) for use with miniature position sensing (T2, T3, T4) – add \$3.20 per track. See page 1.9 for track location details. See Position Sensing Solutions, page 8.3 for switch selection information.

LOW TEMPERATURE (N)

Temperature Range: -40° to 200°F

- Single acting add \$1.05
- Reverse acting add \$1.40
- Double acting add \$2.05
- DXDE add \$2.70

HIGH TEMPERATURE "U" CUPS (V)

Temperature Range: 0° to 400°F (-18° to 205°C)

- Single acting add \$6.25
- Double acting add \$15.50
- DXDE add \$19.85
- Reverse acting add \$10.70

MOLYCOATED BODY (F)

- Add \$3.00 per inch of stroke

NON-LUBE SERVICE (E)

- Single acting add \$4.30
- Double acting add \$10.35
- DXDE add \$14.60

STAINLESS STEEL ROD (prefix SR)

- Add \$3.30
- Standard on DXDE, DXDEH and M option

ROD WIPER (W)

(not available in standard single acting)

- Add \$3.20
- DXDE add \$6.40

LOW PRESSURE HYDRAULIC (HL)

- 250 psi maximum
- Double acting models only
- Option specified as a prefix
- Add \$15.20

Standard Air Cylinders

Three-Position Cylinders

Cushion Cylinders

MRS® Cylinders

Non-Rotating Cylinders

PC Cylinders

All Stainless Non-Repairable

All Stainless Repairable

Z Line Air Cylinders

Rod Lock Cylinders

500 Hydraulic Cylinders

Hole Punch Cylinders

MODEL/PRICE

DESCRIPTION/WEIGHT (lbs.)

DIMENSIONS

12



\$25.30

BASE PRICE

Add \$3.90 per inch of stroke

Single Acting – Spring Return – Front Nose Mounting
Standard Stroke Lengths:
 ½", 1", 1½", 2", 2½", 3", 4"
 Maximum Stroke – 6"
 Optional Stainless Steel Rod
 Optional Accessory:
 D-241 Mounting Bracket
 Base Weight: .39
 Adder Per Inch of Stroke: .21

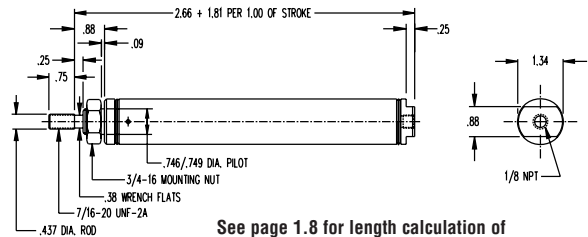

See page 1.8 for length calculation of fractional stroke for single acting cylinders.

12 -NR



\$28.35

BASE PRICE





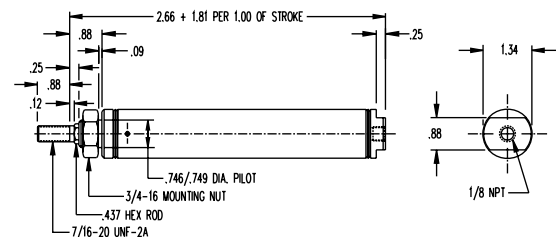

Add \$3.90 per inch of stroke

Single Acting – Non-rotating Hexagon Rod – Spring Return – Front Nose Mounting
Standard Stroke Lengths:
 ½", 1", 1½", 2", 2½", 3", 4"
 Maximum Stroke – 6"
 Optional Stainless Steel Rod
 Optional Accessory:
 D-241 Mounting Bracket
 Base Weight: .41
 Adder Per Inch of Stroke: .20

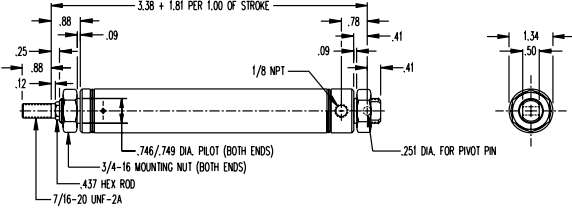

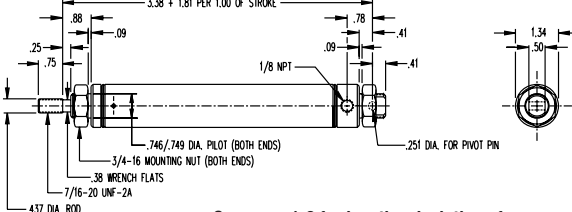

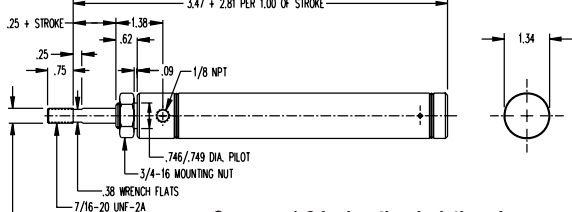

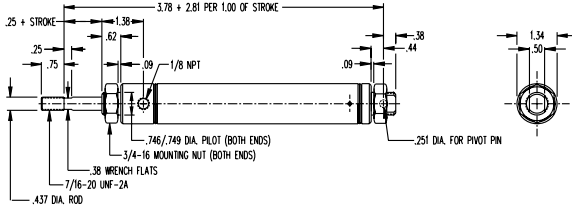

See page 1.8 for length calculation of fractional stroke for single acting cylinders.

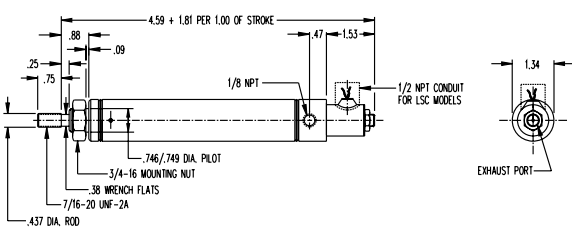
1 - 1/4" Bore Air Cylinders

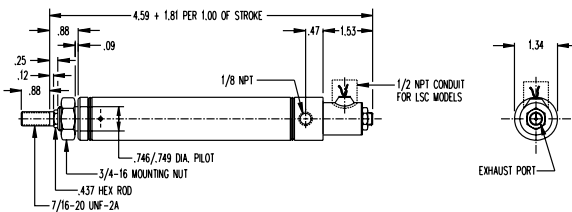

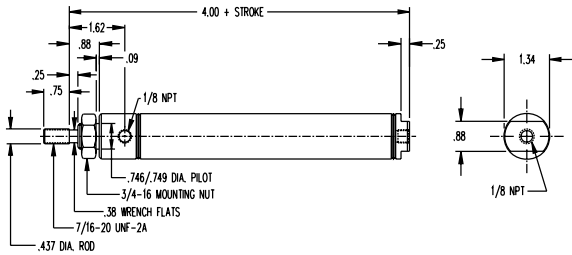
MODEL/PRICE	DESCRIPTION/WEIGHT (lbs.)	DIMENSIONS
<p>12□-NRP</p>  <p>\$34.45 BASE PRICE Add \$3.90 per inch of stroke</p>	<p>Single Acting – Non-rotating Hexagon Rod – Pivot Type – Spring Return – Rear Pivot or Double End Mounting</p> <p>Standard Stroke Lengths: 1/2", 1", 1 1/2", 2", 2 1/2", 3", 4" Maximum Stroke – 6" Optional Stainless Steel Rod Optional Accessories: D-231-1 Piston Rod Clevis D-1360 Pivot Brackets Base Weight: .41 Adder Per Inch of Stroke: .20</p>	 <p>See page 1.8 for length calculation of fractional stroke for single acting cylinders.</p>
<p>12□-P</p>  <p>\$31.20 BASE PRICE Add \$3.90 per inch of stroke</p>	<p>Single Acting – Pivot Type – Spring Return – Rear Pivot or Double End Mounting</p> <p>Standard Stroke Lengths: 1/2", 1", 1 1/2", 2", 2 1/2", 3", 4" Maximum Stroke – 6" Optional Stainless Steel Rod Optional Accessories: D-231-1 Piston Rod Clevis D-1360 Pivot Brackets Base Weight: .53 Adder Per Inch of Stroke: .21</p>	 <p>See page 1.8 for length calculation of fractional stroke for single acting cylinders.</p>
<p>12□-R</p>  <p>\$33.00 BASE PRICE Add \$3.90 per inch of stroke</p>	<p>Reverse Single Acting – Pull Type – Rod Normally Extended – Spring Return – Front Nose Mounting</p> <p>Standard Stroke Lengths: 1/2", 1", 1 1/2", 2", 2 1/2", 3", 4" Maximum Stroke – 6" Optional Stainless Steel Rod Optional Accessory: D-241 Mounting Bracket Base Weight: .50 Adder Per Inch of Stroke: .21</p>	 <p>See page 1.8 for length calculation of fractional stroke for single acting cylinders.</p>
<p>12□-RP</p>  <p>\$35.45 BASE PRICE Add \$3.90 per inch of stroke</p>	<p>Reverse Single Acting – Pivot and Pull Type – Rod Normally Extended – Spring Return – Rear Pivot Mounting</p> <p>Standard Stroke Lengths: 1/2", 1", 1 1/2", 2", 2 1/2", 3", 4" Maximum Stroke – 6" Optional Stainless Steel Rod Optional Accessories: D-231-1 Piston Rod Clevis D-1360 Pivot Bracket Base Weight: .57 Adder Per Inch of Stroke: .21</p>	 <p>See page 1.8 for length calculation of fractional stroke for single acting cylinders.</p>

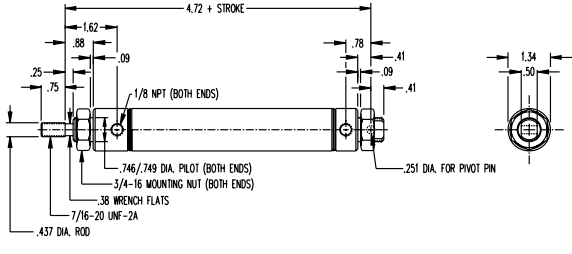
1-1/4" Bore Air Cylinders

MODEL/PRICE	DESCRIPTION/WEIGHT (lbs.)	DIMENSIONS
<p>12□-LS or LSC*</p>  <p>\$88.25 BASE PRICE Add \$3.90 per inch of stroke *Add \$2.25 for Conduit Outlet</p>	<p>Single Acting – Built-in Midget 3-Way Solenoid Operated Valve – Spring Return – Front Nose Mounting – 150 PSI, 3/64" Orifice Standard Stroke Lengths: 1/2", 1", 1 1/2", 2", 2 1/2", 3", 4" Maximum Stroke – 6" Optional Stainless Steel Rod Standard Voltage – 115/60 Optional Voltages: 24, 230 A.C. or 6, 12, 24 D.C. Optional Accessory: D-241 Mounting Bracket Base Weight: 1.30 Adder Per Inch of Stroke: .21</p>	 <p>See page 1.8 for length calculation of fractional stroke for single acting cylinders.</p>
<p>12□-NRLS or NRLSC*</p>  <p>\$91.75 BASE PRICE Add \$3.90 per inch of stroke *Add \$2.25 for Conduit Outlet</p>	<p>Single Acting – Non-rotating Hexagon Piston Rod – Built-in Midget 3-Way Solenoid Operated Valve – Spring Return – Front Nose Mounting – 150 PSI, 3/64" Orifice Standard Stroke Lengths: 1/2", 1", 1 1/2", 2", 2 1/2", 3", 4" Maximum Stroke – 6" Optional Stainless Steel Rod Standard Voltage – 115/60 Optional Voltages: 24, 230 A.C. or 6, 12, 24 D.C. Optional Accessory: D-241 Mounting Bracket Base Weight: 1.30 Adder Per Inch of Stroke: .21</p>	 <p>See page 1.8 for length calculation of fractional stroke for single acting cylinders.</p>
<p>12□-D</p>  <p>\$32.25 BASE PRICE Add \$2.35 per inch of stroke</p>	<p>Double Acting – Air Return – Front Nose Mounting Standard Stroke Lengths: 1/2", 1", 1 1/2", 2", 2 1/2", 3", 4", 5", 6" Maximum Stroke – 12" Optional Stainless Steel Rod Optional Accessory: D-241 Mounting Bracket Base Weight: .58 Adder Per Inch of Stroke: .08</p>	
<p>12□-DP</p>  <p>\$38.40 BASE PRICE Add \$2.35 per inch of stroke</p>	<p>Double Acting – Pivot Type – Air Return – Rear Pivot or Double End Mounting Standard Stroke Lengths: 1/2", 1", 1 1/2", 2", 2 1/2", 3", 4", 5", 6", 7", 8", 9", 10", 11", 12" Maximum Stroke – 32" Optional Stainless Steel Rod Optional Accessories: D-231-1 Piston Rod Clevis D-1360 Pivot Brackets D-241 Mounting Bracket Base Weight: .71 Adder Per Inch of Stroke: .08</p>	

- Standard Air Cylinders
- Three-Position Cylinders
- Cushion Cylinders
- MRS® Cylinders
- Non-Rotating Cylinders
- PC Cylinders
- All Stainless Non-Repairable
- All Stainless Repairable
- Z Line Air Cylinders
- Rod Lock Cylinders
- 500 Hydraulic Cylinders
- Hole Punch Cylinders

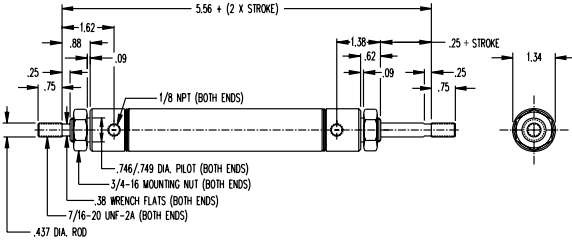
1-1/4" Bore Air Cylinders

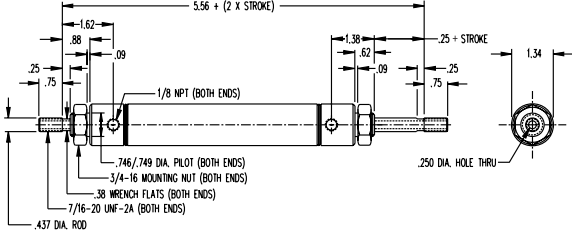
MODEL/PRICE	DESCRIPTION/WEIGHT (lbs.)	DIMENSIONS
12□-DXDE  \$54.55 BASE PRICE Add \$3.40 per inch of stroke	Double Acting – Double End Rod – Air Return – Double End Mounting Standard Stroke Lengths: ½", 1", 1½", 2", 2½", 3", 4", 5", 6", 7", 8", 9", 10", 11", 12" Maximum Stroke – 12" Stainless Steel Rod Standard Optional Accessory: D-241 Mounting Bracket Base Weight: .98 Adder Per Inch of Stroke: .12	
12□-DXDEH  \$60.40 BASE PRICE Add \$3.60 per inch of stroke	Double Acting – Double End Hollow Rod – Air Return – Double End Mounting Standard Stroke Lengths: ½", 1", 1½", 2", 2½", 3", 4", 5", 6" Maximum Stroke – 12" Stainless Steel Rod Standard Optional Accessory: D-241 Mounting Bracket Base Weight: .97 Adder Per Inch of Stroke: .12	

1-1/4" Bore Accessories

D-241
\$5.70

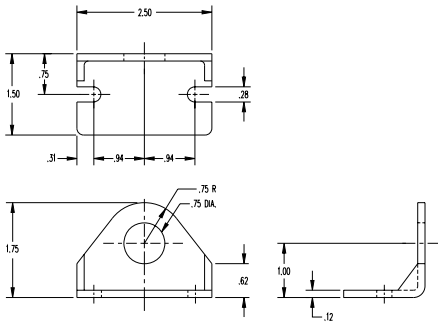

Mounting Bracket
(for Single & Double Acting Models)

D-1360
\$7.40

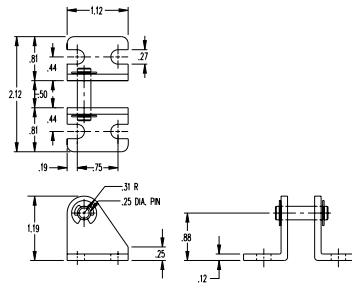

Pivot Brackets

D-231-1
\$6.45

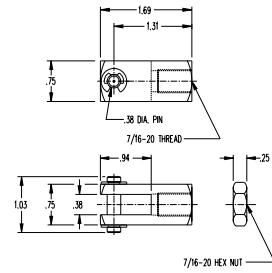

Piston Rod Clevis

D-3556
\$.90

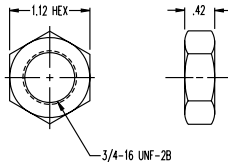

Mounting Nut